

Varenummer: 203180M1080B1S
 Beskrivelse: E+G Justerfod
 GN 31-80-M10-80-B1-S
 Note: S Uden møtrik, udvendig sekskant i bunden

Mål

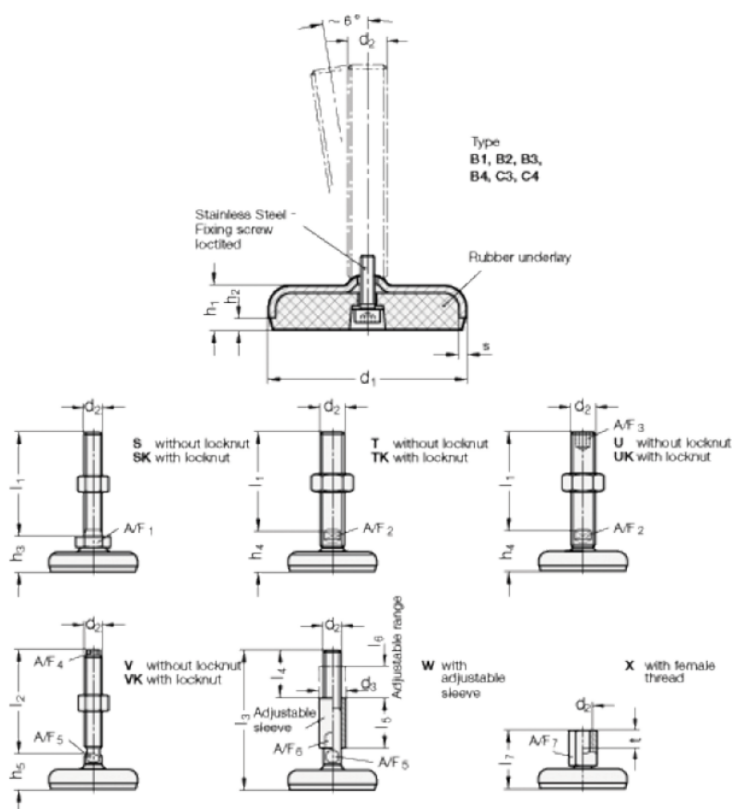

A/F1-	= 17
d1	= 80
d2	= 10
h1	= 18
h2	= 5
h3 +4.0/0	= 26
l1	= 80
s	= 3